

Since 1968

COMMAX
SmartHome & Security

User Manual

CIOT-L10M



<https://aros.kz>

www.commax.com

COMMAX Co.,Ltd.



- Thank you for purchasing COMMAX products.
- Please carefully read this User's Guide (in particular, precautions for safety) before using a product and follow instructions to use a product exactly.
- The company is not responsible for any safety accidents caused by abnormal operation of the product.

Table of Contents

Safety Warning & Caution	2
1. CONFIGURATION	4
2. Screen Setting	5
1.1. Initial Screen	5
2.1. Status Icon	5
3. Guard Call	6
4. Household Call	7
4.1. Call Among Household	7
5. Entry Authorization	8
5.1. Entry with RF-Card	8
6. Registration of Smart E-Key & Door Open	9
6.1. Registration of Smart E-Key	9
6.2. Open the Door at the Lobby	10
7. Web settings	11
7.1. System Info	12
7.1.1. Version Info	12
7.1.2. Easy Setup	12
7.2. Network Info	13
7.2.1. Network Info	13
7.2.2. Server Info	13
7.2.3. System Reboot	14
7.3. System Setting	14
7.3.1. Password	14
7.3.2. VoIP	15
7.3.3. Audio	15
7.3.4. Video	16
7.3.5. Management	16
7.3.6. Extra Confi	16
7.3.7. Call Button	18
7.3.8. Factory Reset	19
7.4. Initialize the Password	19
8. Wiring Diagram	20
9. Specification	20

Safety Warning & Caution

Please follow the things described below in order to prevent any danger or property damage.

	<p>Warning It may cause a serious damage or injury if violated.</p>		<p>Prohibition.</p>
	<p>Caution It may cause a minor damage or injury if violated.</p>		<p>No disassembly</p>
			<p>No touch</p>
			<p>Must follow strictly.</p>
			<p>Shows plugging out the power cord without an exception</p>
			<p>Shows the warning and caution for an electric shock.</p>
			<p>Shows the warning and caution for a fire.</p>

Warning

Power & Installation

<p>Please don't use several products at the same time on one power socket. · It may cause a fire due to an abnormal overheating.</p> <p> </p> <p>Prohibition Fire</p>	<p>Please don't bend the power cable excessively or it may cause an electric shock. · fire when using a damaged power cable.</p> <p> </p> <p>Prohibition Electric shock Fire</p>	<p>Please don't handle the power cable with a wet hand. · It may cause an electric shock.</p> <p> </p> <p>Prohibition Fire</p>	<p>Please plug out the power cable from the socket when not using it for a long period of time. · It may shorten the product lifespan or cause a fire.</p> <p> </p> <p>Request Fire</p>
<p>Please don't install the product in the place where there is much oil, smoke or humidity. · It may cause an electric shock or fire.</p> <p> </p> <p>Prohibition Electric shock Fire</p>	<p>Please don't install the product with the lightning and thunder. · It may cause an electric shock or fire.</p> <p> </p> <p>Prohibition Electric shock Fire</p>	<p>Please don't use and connect this product with other products with different rated voltage · It may cause a disorder or fire.</p> <p> </p> <p>Prohibition Fire</p>	<p>When installing the product that generates heat, please install the product away from the wall (10cm) for the ventilation. · It may cause a fire due to the increased internal temperature.</p> <p> </p> <p>Prohibition Fire</p>

⚠ Warning

Cleaning & Use

Please don't disassemble, repair or rebuild this product arbitrarily (please contact the service center if a repair is needed).

- It may cause an electric shock or fire.



No disassembly



Electric shock Fire Unplug

If an abnormal sound, burning smell or smoke is coming out of the product, please plug out the power cable and contact a service center.

- It may cause an electric shock or fire.



Electric shock Fire

Please don't insert any metallic or burnable materials into the ventilation hole.

- It may cause an electric shock or fire.

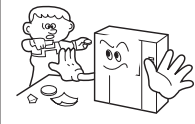

Prohibition Electric shock Fire

Please use only the designated batteries for the products of using DC power.

- It may cause an electric shock or fire.

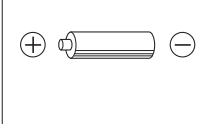

Request

⚠ Caution

Power & Installation

Please plug the power cable firmly into the inner end

- It may cause a fire.



Request Fire

Please hold the plug tightly when unplugging the power cable (a part of the copper wire may be disconnected if the grabbing is only made on the cord when pulling out the cable).

- It may cause an electric shock or fire



Request Electric shock Fire

When connecting the power cables after cutting the cable, please install the product with power off

- It may cause an electric shock or fire



Request Electric shock Fire

When installing the product, please fix it firmly while using the wall-mounting unit and screws.

- It may cause an injury from the falling object.

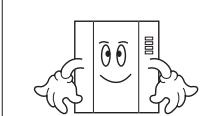

Request

Please be careful when using an AC circuit breaker since there is a possibility of an electric shock.

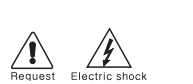
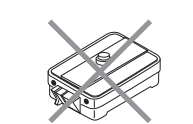

Request Electric shock

Please check the use voltage and current for the DC-only products and use the appropriate rectifier.

- It may cause a fire.



Request Fire

Please avoid direct rays of the sun or heating devices at a time of installation.

- It may cause a fire.



Request Overheating Fire

Please don't install the product on an unstable place or small support board.

- It may cause an injury if it falls down while in use.

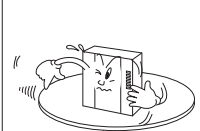

Request

Cleaning & Use

When cleaning the product, please rub it with a soft and dry cloth after plugging out the power cable. (Please don't use any chemical products such as wax, benzene, alcohol or cleanser.)



Prohibition

Please don't drop the product on the ground and don't apply a shock.

- It may cause a failure.

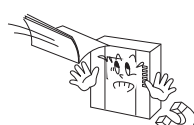

Prohibition

Please use the designated connection cable within the maximum calling distance designated for the product

- It may reduce the product performance.



Request

1. CONFIGURATION

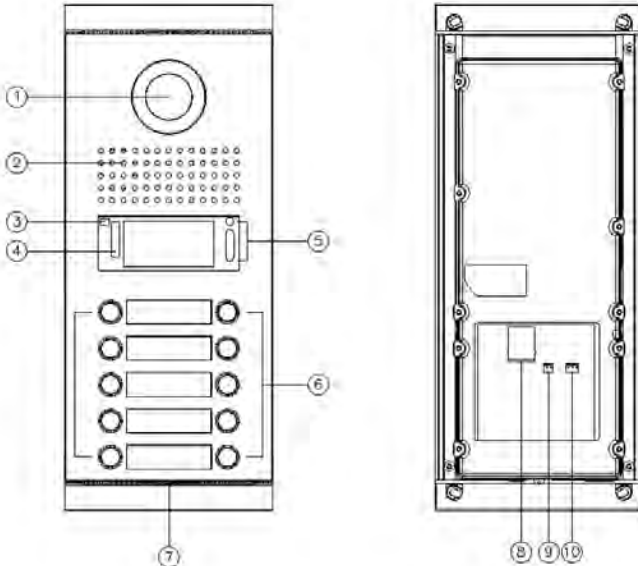

NO	NAME	NO	NAME
1	CAMERA	7	MIC
2	SPEAKER	8	LAN PORT
3	PROXIMITY SENSOR	9	DC14V
4	RF CARD READER	10	SWITCH CONNECTION
5	LED		
6	HOUSEHOLE CALL BURRON		

※ Proximity sensor

- OLED screen turns on automatically when a person approaches within a certain distance (1m).

※ Precautions for using proximity sensor

- If the outdoor temperature is below $-20\text{ }^{\circ}\text{C}$, the proximity sensor may not operate.

2. Screen Setting

2.1. Initial Screen

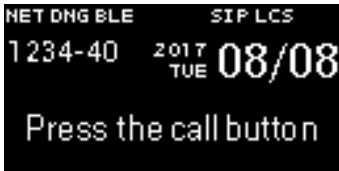

2.2. Status Icon

Icon	Description	Icon	Description
NET	LAN Connectivity	REG	Connected to Server
OUT	OUT-Door Lobby Phone	SIP	Unconnected to Server
DNG	Building Lobby Phone	LCS	Local Server Connectivity
Dat	RF-Card Data Storage status		
BLE	BLE Connectivity Stats		

3. Guard Call

- ① Press the Guard Station button specified by WEB.
- ② Call Guard Station with Ring Sound.
- ③ When Guard Answers the Call, Talk to Guard (Talk Time: 1Minute)
- ④ Press any Button If you want to Hang up.
- ⑤ When Guard Press "Door Open" Button, Door Open with "Door Open" Sound
- ⑥ If you Listen to "beEP" Sound, It Means the Line is busy. so, Please Call Later.

※ You can Call the Guard Which Was Registered by Operator.

4. Household Call

3.1. Call Among Household

- I. You must first assign the Dongho number for each button in WEB



PIC.1. Household No. Registration Screen

- ① Press the Room button specified by WEB
- ② Call the Household with Ring Sound.
- ③ When the Household Answers the Call, Talk to the Household (Talk Time: 1Minute)
- ④ Press any Button If you want to Hang up.
- ⑤ When Household Press "Door Open" Button, Door Open with "Door Open" Sound

5. Entry Authorization

5.1. Entry with RF-Card

- ① Put RF-Card on card Reader.
- ② If Authorized, Door Open with "Door Open" Sound.
- ③ If Unauthorized, It Sounds a Dull Warning Sound.



PIC.4. Putting RF-card

※ Only the card registered by the administrator is available in advance.

6. Registration of Smart E-Key & Door Open

6.1. Registration of Smart E-Key

- ① Memorize 'Gate name' Indicated In the Screen top of LobbyPhone. (EX: Gatename 0106-47)
- ② Input Gate name In 'Building/Lobby number'
- ③ Input the number of Household (EX: 101)
- ④ Input Password to Access to the Building (Password for a Wallpad)
- ⑤ Enter the Button 'Registration'

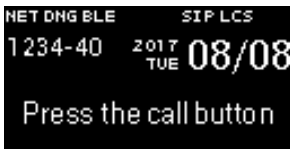

※ Precautions

- 1. Do not use the numbers '1234, 4321, 0000' as a Password for Wall pad.
- 2. Do not use the number '9999' for Building/Household number
- 3. The Maximum Quantity of E-Key Registration is 7 Keys. need to remove former E-Key to ADD.

6.2. Open the Door at the Lobby.

- ① Press the Button 'Door Open' In GREEN Color.
- ② the Door is Open after two Seconds.



※ Precautions

- In Case of Change or Deletion of Lobby Password, Please Register E-Key once again.
- ※ BLE Module name set-up
 - BLE Module name will be Combined Call Prefix number with System ID.
(EX) Call Prefix : 106, System ID : 40
Gate (BLE Module name) : 0106-40
 - BLE Function is not Available with Outdoor Lobby Phone

7. Web settings

It is Available to Access to the WEB System Inputting IP Address In Internet Browser.
(EX : <http://10.254.1.17/login.php>)



- ① Input the Password for the panel (Initial Password : 0000)
 - ② Push the Button "login"
- ※ Computer and Lobby Phone should be Connected In the same Network.

7.1. System Info

7.1.1. Version Info

- Check the version of system

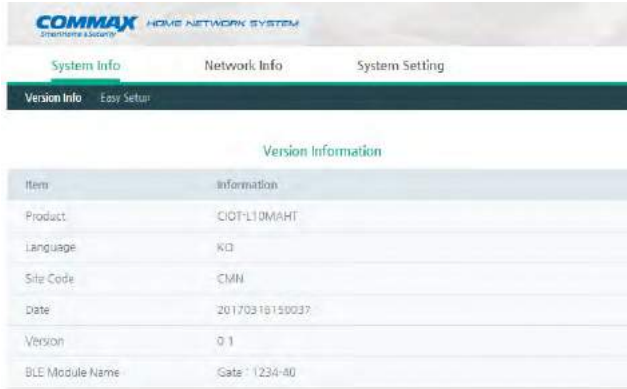

7.1.2. Easy Setup

- Call Prefix : Input the number of the Building
 - * If you Do not Register the Building number, Date Input Screen will DisPLAY Automatically.
- System ID : Input Serial number of the Lobby Phone
- Guard ID : Input Guard ID

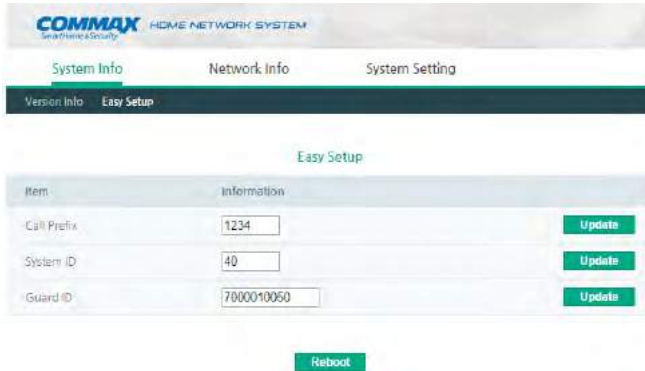

※ after Changing Call Prefix/System ID/Guard ID, Please Press the Button “update” of Each Item and Reboot the system.

7.2. Network Info

7.2.1. Network Info

- IP Address : Input IP Address
 - Subnet Mask : Input Subnet Mask
 - Gateway : Input Gateway Address
 - DNS : Input DNS Address
- * after Setting all Information, Please Reboot the system.

The screenshot shows the 'Network Info' configuration page. The header includes 'COMMAX HOME NETWORK SYSTEM' and navigation tabs for 'System Info', 'Network Info', and 'System Setting'. Below the tabs is a sub-menu with 'Network Info', 'Server Info', and 'System Reboot'. The main content area is titled 'Network Information' and contains a table with four rows: IP Address, Subnet Mask, Gateway, and DNS. Each row has input fields for the respective values and an 'Update' button.

Item	Information	
IP Address	<input type="text" value="10"/> <input type="text" value="254"/> <input type="text" value="1"/> <input type="text" value="17"/>	<input type="button" value="Update"/>
Subnet Mask	<input type="text" value="255"/> <input type="text" value="0"/> <input type="text" value="0"/> <input type="text" value="0"/>	<input type="button" value="Update"/>
Gateway	<input type="text" value="10"/> <input type="text" value="1"/> <input type="text" value="1"/> <input type="text" value="254"/>	<input type="button" value="Update"/>
DNS	<input type="text" value="168"/> <input type="text" value="126"/> <input type="text" value="63"/> <input type="text" value="1"/>	<input type="button" value="Update"/>

7.2.2. Server Info

- Local Server : Input Local Server Address
- SIP Server : Input SIP Server Address
- Update Server : Input update Server Address

The screenshot shows the 'Server Info' configuration page. The header includes 'COMMAX HOME NETWORK SYSTEM' and navigation tabs for 'System Info', 'Network Info', and 'System Setting'. Below the tabs is a sub-menu with 'Network Info', 'Server Info', and 'System Reboot'. The main content area is titled 'Server Information' and contains a table with three rows: Local Server, SIP Server, and Update Server. Each row has input fields for the respective values and an 'Update' button.

Item	Information	
Local Server	<input type="text" value="10"/> <input type="text" value="0"/> <input type="text" value="0"/> <input type="text" value="2"/>	<input type="button" value="Update"/>
SIP Server	<input type="text" value="10"/> <input type="text" value="0"/> <input type="text" value="0"/> <input type="text" value="2"/>	<input type="button" value="Update"/>
Update Server	<input type="text" value="10.0.0.2"/>	<input type="button" value="Update"/>

7.2.3. System Reboot

- push the Button "Reboot" for all Settings to be applied.



7.3. System Setting

7.3.1. Password

- Current Password
- New Password
- Re Password : Confirm new Password

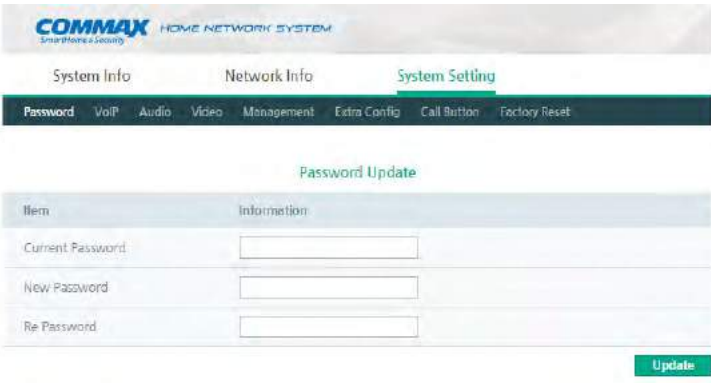

7.3.2. VoIP

- Guard ID : Input Guard ID

VoIP

Item	Information	
Guard ID	<input type="text" value="7000010050"/>	Update

7.3.3. Audio

- General SPC Volume : Speaker Volume Control When Calling Household
- General MIC Volume : Microphone Volume Control When Calling Household
- Guard SPC Volume : Speaker Volume Control When Calling Guard
- Guard MIP Volume : Microphone Volume Control When Calling Guard
- Key Sound : Setting Key Sound
- Ring Sound : Setting Ring Sound
- Key Volume : Setting Key Volume
- Ring Volume : Setting Ring Volume
- Effect Volume : Setting Sound EFFECT Volume
- Number Speech : Setting Voice Button of Building/Household numbers

Audio

Item	Information	
Gener SPC Volume	<input type="text" value="2(0dB)"/>	Update
Gener MIC Volume	<input type="text" value="2(18dB)"/>	Update
Guard SPC Volume	<input type="text" value="2(-3dB)"/>	Update
Guard MIC Volume	<input type="text" value="2(22dB)"/>	Update
Key Sound	<input type="text" value="Key 1"/>	Update
Ring Sound	<input type="text" value="Happy Day"/>	Update
Key Volume	<input type="text" value="7(14)"/>	Update
Ring Volume	<input type="text" value="7(14)"/>	Update
Effect Volume	<input type="text" value="7(14)"/>	Update
Number Speech	<input type="text" value="Use"/>	Update

7.3.4. Video

- Video Quality : Adjust Video Quality
 - * Available to Adjust the Quality by 1M/2M/3M
 - ※ Date size Increases In Higher Quality

Video	
Item	Information
Video Quality	2M <input type="button" value="Update"/>

7.3.5. Management

- Call Prefix : Setting Household number
- System ID : Input the Serial number of the Product
- Call Min Line : Input Minimum Call Line
- Call Max Line : Input Maximum Call Line
- BLE Intensity : Setting BLE Intensity
- Proximity Sensor Distance : Setting the Range of Distance Measurement of ADC Sensor
 - * In Case of exposed to Direct Sunlight, Distance will Shorten.
- Proximity Sensor Hold Type : Setting Detection Hold Time

Management	
Item	Information
Call Prefix	1234 <small>Reboot is required after update.</small> <input type="button" value="Update"/>
System ID	40 <small>Reboot is required after update.</small> <input type="button" value="Update"/>
Call Min Line	0 <input type="button" value="Update"/>
Call Max Line	0 <input type="button" value="Update"/>
BLE Intensity	5 <input type="button" value="Update"/>
Proximity Sensor Distance	80cm <input type="button" value="Update"/>
Proximity Sensor Hold Time	300ms <input type="button" value="Update"/>

7.3.6. Extra Config

- Language : Setting Language
- Door Open Time : Setting Time for Door Open
 - * 2, 5, 10, 15, 20, 25 SEC. Selection

- Sleep Mode Time : Setting Time of OLCD Sleep Mode
 - * 30 SEC., 1, 2, 3, 4, 5 Min. Selection
- Key Time Out
 - * 10, 20, 30 SEC. Selection
- Use 24-hour format : Select the type of Time (24Hours)
- Off-Line Password : Enter the Password to Open the Door When offline
 - * Initial off-Line Password is 123456

Extra Config

Item	Information	
Language	English ▼	Update
Door Open Time	5 Sec ▼	Update
Sleep Mode Time	30 Sec ▼	Update
Key Timeout	10 Sec ▼	Update
Use 24-hour Format	No ▼	Update
Off-line Password	123456	Update

7.3.7. Call Button

- Guard Setting : Available to set only one Button In the panel.
- Unused : not use the Button

Button	Call Number	Guard	Unused	Button	Call Number
Button 1	<input type="text" value="5678"/>	<input type="checkbox"/>	<input type="checkbox"/>	Button 2	<input type="text" value="0000"/>
Button 3	<input type="text" value="0000"/>	<input type="checkbox"/>	<input checked="" type="checkbox"/>	Button 4	<input type="text" value="0000"/>
Button 5	<input type="text" value="0000"/>	<input type="checkbox"/>	<input checked="" type="checkbox"/>	Button 6	<input type="text" value="0000"/>
Button 7	<input type="text" value="0000"/>	<input type="checkbox"/>	<input checked="" type="checkbox"/>	Button 8	<input type="text" value="0000"/>
Button 9	<input type="text" value="0000"/>	<input type="checkbox"/>	<input checked="" type="checkbox"/>	Button 10	<input checked="" type="checkbox"/>

Update

Button	Call Number	Unused	Button	Call Number	Unused
Button 1	<input type="text" value="0000"/>	<input checked="" type="checkbox"/>	Button 2	<input type="text" value="0000"/>	<input checked="" type="checkbox"/>
Button 3	<input type="text" value="0000"/>	<input checked="" type="checkbox"/>	Button 4	<input type="text" value="0000"/>	<input checked="" type="checkbox"/>
Button 5	<input type="text" value="0000"/>	<input checked="" type="checkbox"/>	Button 6	<input type="text" value="0000"/>	<input checked="" type="checkbox"/>
Button 7	<input type="text" value="0000"/>	<input checked="" type="checkbox"/>	Button 8	<input type="text" value="0000"/>	<input checked="" type="checkbox"/>
Button 9	<input type="text" value="0000"/>	<input checked="" type="checkbox"/>	Button 10	<input type="text" value="0000"/>	<input checked="" type="checkbox"/>
Button 11	<input type="text" value="0000"/>	<input checked="" type="checkbox"/>	Button 12	<input type="text" value="0000"/>	<input checked="" type="checkbox"/>
Button 13	<input type="text" value="0000"/>	<input checked="" type="checkbox"/>	Button 14	<input type="text" value="0000"/>	<input checked="" type="checkbox"/>
Button 15	<input type="text" value="0000"/>	<input checked="" type="checkbox"/>	Button 16	<input type="text" value="0000"/>	<input checked="" type="checkbox"/>
Button 17	<input type="text" value="0000"/>	<input checked="" type="checkbox"/>	Button 18	<input type="text" value="0000"/>	<input checked="" type="checkbox"/>
Button 19	<input type="text" value="0000"/>	<input checked="" type="checkbox"/>	Button 20	<input type="text" value="0000"/>	<input checked="" type="checkbox"/>
Button 21	<input type="text" value="0000"/>	<input checked="" type="checkbox"/>	Button 22	<input type="text" value="0000"/>	<input checked="" type="checkbox"/>
Button 23	<input type="text" value="0000"/>	<input checked="" type="checkbox"/>	Button 24	<input type="text" value="0000"/>	<input checked="" type="checkbox"/>

Update

7.3.8. Factory Reset

- System is Reset to the Factory Settings
- * Changed IP is not Initialization .



7.4. Initialize the Password

- Input "Lobby IP/key_event.php" Into the WEB BROWSER.
- (EX : http://10.254.1.17/key_event.php)

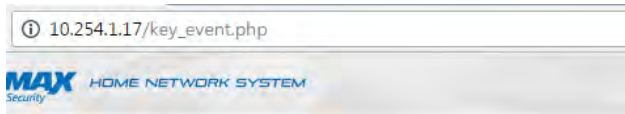

- ※ Please Change the Initial Password(0000) for SAFETY.
- ※ How to Initialize : Prg + "0000" + Prg + Key + Guard + Prg + Bell

8. Wiring Diagram

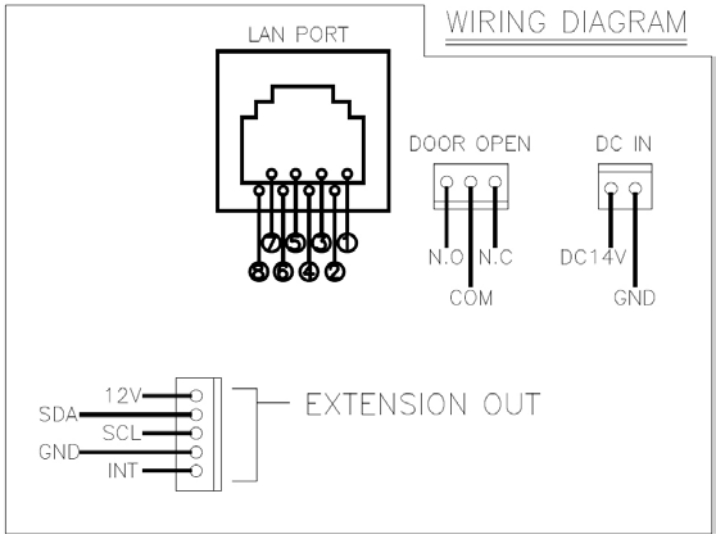

9. Specifications

Model name	7 € H!@10A
Specification	
Transmission	TCP/IP
Voltage	DC14V/1.8A
Power Consumption	Max : 1.4A Standby :0.35A
Telecommunication	VoIP
Display	&"(" CL9D
Video Format	H.264 / MPEG4
Camera Pixel	&"\$ 'A Y['U'D] Y`
Call tone	Electric chime : 3 Melody 2 times
Temperature	Using : - 40° ~ 50 °