

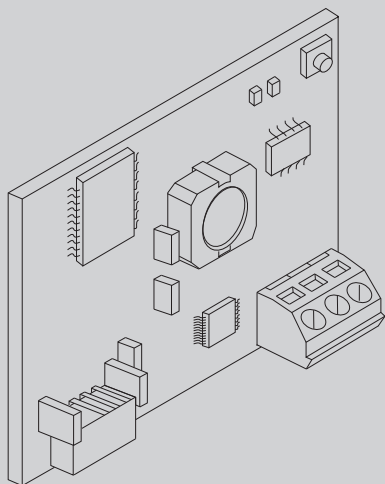

<https://aros.kz>

SCHEDA OPZIONALE
OPTIONAL BOARD
CARTE EN OPTION
OPTIONALE KARTE
TARJETA OPCIONAL
OPTIONELE KAART



ISTRUZIONI DI INSTALLAZIONE
INSTALLATION MANUAL
INSTRUCTIONS D'INSTALLATION
MONTAGEANLEITUNG
INSTRUCCIONES DE INSTALACION
INSTALLATIEVOORSCHRIFTEN

B EBA WI-FI GATEWAY

BFT



AZIENDA CON SISTEMA DI GESTIONE
INTEGRATO CERTIFICATO DA DNV
= UNI EN ISO 9001:2008 =
UNI EN ISO 14001:2004

Attenzione! Leggere attentamente le "Avvertenze" all'interno! **Caution!** Read "Warnings" inside carefully!
Attention! Veuillez lire attentivement les Avertissements qui se trouvent à l'intérieur! **Achtung!** Bitte lesen Sie aufmerksam die „Hinweise“ im Inneren!
¡Atención! Leer atentamente las "Advertencias" en el interior! **Let op!** Lees de "Waarschuwingen" tigre aan de binnenkant zorgvuldig!



DEMOLIZIONE L'eliminazione dei materiali va fatta rispettando le norme vigenti. Non gettate il vostro apparecchio scartato, le pile o le batterie usate nei rifiuti domestici. Avete la responsabilità di restituire tutti i vostri rifiuti da apparecchiature elettriche o elettroniche lasciandoli in un punto di raccolta dedicato al loro riciclo.



SCRAPPING Materials must be disposed of in accordance with the regulations in force. Do not throw away your discarded equipment or used batteries with household waste. You are responsible for taking all your waste electrical and electronic equipment to a suitable recycling centre.



DÉMOLITION Éliminez les matériaux en respectant les normes en vigueur. Ne jetez ni les vieux appareils, ni les piles, ni les batteries usées avec les ordures domestiques. Vous devez confier tous vos déchets d'appareils électriques ou électroniques à un centre de collecte différenciée, préposé à leur recyclage.



VERSCHROTTUNG Die Entsorgung der Materialien muss unter Beachtung der geltenden Normen erfolgen. Bitte werfen Sie Ihr Altgerät oder die leeren Batterien nicht in den Haushaltsabfall. Sie sind verantwortlich für die ordnungsgemäße Entsorgung Ihrer elektrischen oder elektronischen Altgeräte durch eine offizielle Sammelstelle.



DESGUACE La eliminación de los materiales se debe realizar respetando las normas vigentes. No desechar su equipo descartado, las pilas o las baterías usadas con los residuos domésticos. Usted tiene la responsabilidad de desechar todos sus residuos de equipos eléctricos o electrónicos, entregándolos a un punto de recogida dedicado al reciclaje de los mismos.



SLOOP De materialen moeten verwijderd worden met inachtneming van de geldende normen. Uw niet meer gebruikte apparaat, de lege batterijen of accu's niet bij het huisvuil weggooien. U bent er verantwoordelijk voor al uw afval van elektrische of elektronische apparatuur weg te brengen naar een inzamelpunt voor de recycling ervan.

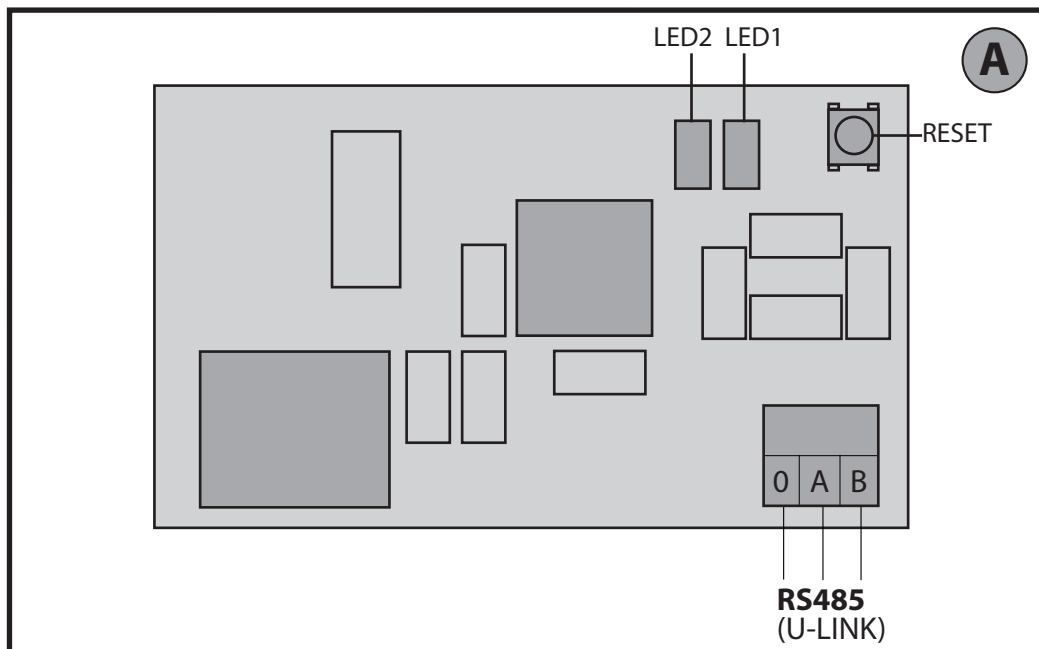

Max.32 centrali / Max. 32 control panels /Maxi 32 centrales
 Max. 32 Steuergeräte / Máx.32 centrales /Max.32 centrales

B



LEGENDA - KEY
LÉGENDE - LEGENDE
LEYENDA - LEGENDA

= ON
 = OFF

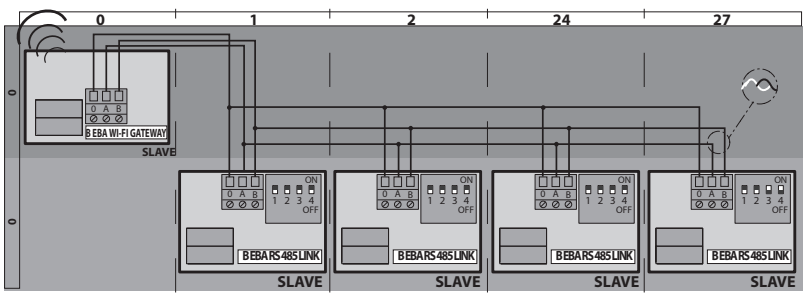

SM -->Modo seriale / Serial mode / Mode série / Serieller Modus / Modo serial / Serielle modus
ADD-->Indirizzo/Address / Adresse / Adresse / Dirección / Adres

CASO 1: CONFIGURAZIONE COME ACCESS POINT / CASE 1: CONFIGURATION AS ACCESS POINT
CAS 1 : CONFIGURATION COMME POINT D'ACCES / FALL 1: KONFIGURIERUNG ALS ACCESS POINT
CASO 1: CONFIGURACIÓN COMO ACCESS POINT / GEVAL 1: CONFIGURATIE ZOALS TOEGANGSPUNT

C

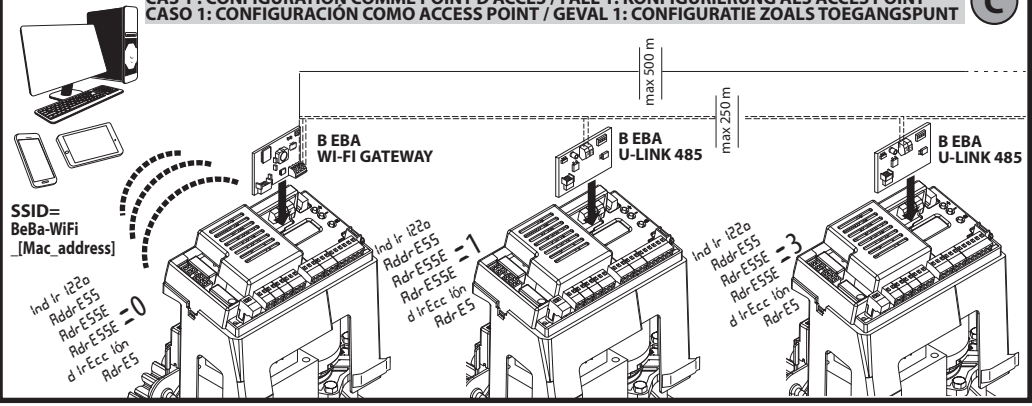

CASO 2: CONFIGURAZIONE COME CLIENT / CASE 2: CONFIGURATION AS CLIENT
CAS 2 : CONFIGURATION COMME CLIENT / FALL 2: KONFIGURIERUNG ALS CLIENT
CASO 2: CONFIGURACIÓN COMO CLIENT / GEVAL 2: CONFIGURATIE ZOALS KLANT

D

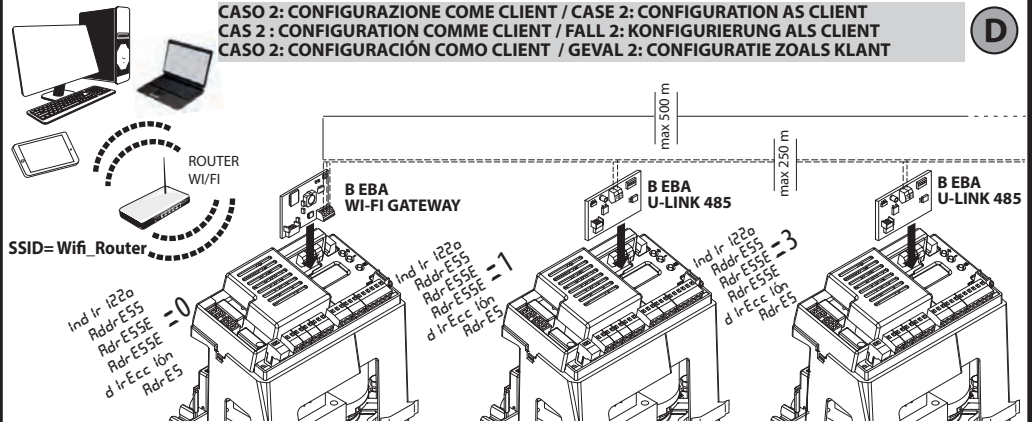

2) GENERAL INFORMATION

The B EBA WI-FI GATEWAY module allows you to connect a supervisor* to the local network of compatible BFT U-link devices by means of TCP/IP technology on the WI-FI Network. The B EBA TCP/IP GATEWAY module must be connected to the only local network device with the address 0. Each network device must have a different address. Using a U-link supervisor*, you can address each device in the local U-link network and manage parameters, settings, transmitters and diagnostics.

For information on the features of the supervisor and available functions, refer to the relevant manual.

The network is made up of a device with a B EBA WI-FI GATEWAY module to which all the other devices are connected using twisted pair cabling in a U-link serial connection.

The smallest possible network is made up of a single device with the address 0 with a B EBA WI-FI GATEWAY module.

Note: this board is compatible only with control panels using the U-link protocol.

(* Supervisor means a handheld programmer or management software.

See figures C and D for examples of installation.

3) TECHNICAL SPECIFICATIONS

Operating temperature	-20°/+50° C
Max. connection distance with cable: -B EBA WI-FI GATEWAY and B EBA RS 485 LINK -B EBA RS 485 LINK and B EBA RS 485 LINK	250 m
Max. network length	500 m*1
Max Max. of devices on 485 network	32*2
B EBA WI-FI GATEWAY band	2400-2483.5 MHz
Dimensions	42 x 29 mm (HxL)
Transmit Power	+16dBm
Receiving Sensitivity	-98dBm
Wi-Fi	- 802.11: b/g/n - Bit rate: 72.2 Mbps - Safety: OPEN, WPA2/WPA Personal and WEP

*1 the max. network length can be extended using an RS 485 repeater.

*2 the number of devices can be increased to 120 using an RS 485 repeater.

4) WIRING REQUIRED FOR OPERATION (Fig.B)

The control panels are connected to each other with 3 wires relating to the B EBA RS 485 LINK interface boards. Use twisted pair cabling only. When using a telephone cable with more than one pair, it is essential to use wires from the same pair (A-B). The length of the cable between one module and the next must not be greater than 250 m.

Terminal	Description
RS485 A RS485 B RS485 0	Connection to the U-link network. Pay attention to the polarity.

5) RESTORING FACTORY SETTINGS

Attention: it restores the factory pre-set settings.

- Press without releasing the RESET button (Fig.A) for 5 seconds.
- After releasing the LED1 button, the LED2 flashes quickly once

6) DIAGNOSTICS (Fig.A)

LED	STATUS	MEANING
LED 1	Fixed Led	Proper initialization and supply of the module
LED 1	Led flashing	Faulty board
LED 2	Led access	The LED detects the U-Link connection to the board

7) INSTALLATION/CONFIGURATION

Warning:

- The images and screenshots used herein may differ from the actual product.

After connecting the B EBA WI-FI GATEWAY to the device in the proper terminal and have wired and configured the U-Link network correctly. The B EBA WI-FI GATEWAY must be configured in one of the following ways.

CONFIGURATION OF THE B EBA WI-FI GATEWAY

8) CASE 1: CONFIGURATION AS ACCESS POINT (FIG.C)

This type of connection allows you to manage a U-Link system with its own SSID (Name of the WLAN) by connecting directly to the B EBA WI-FI GATEWAY of the wifi from the PC, smartphone and/or tablet through the dedicated BFT software.

- 1.Connect the PC, smartphone and/or tablet to the SSID network identified by the name **BeBa_Wifi_<Mac address>** (using WPA2-PSK security type, and the default password BEBAWIFI) defined by the EBA B WI-FI GATEWAY. The Mac address of the B EBA WI-FI GATEWAY is what is on the label on the B EBA WI-FI GATEWAY board.

The methods for connecting to the WiFi network vary depending on the PC, smartphone and/or tablet and operating system adopted, to understand how to connect, check the instructions of the device.

- 2.After connecting to the B EBA WI-FI GATEWAY open the browser (be sure not to have the proxy server active), type in the address bar the default address of 192.168.1.1 of the B EBA WI-FI GATEWAY.

It reaches the current configuration of the module page

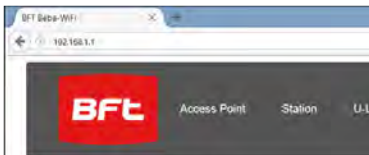
 <p>Current configuration:</p> <p>Mode: Access Point SSID: BeBa-Wifi_000B570B7E51 BSSID: 000B570B7E51</p>	Mode	Operating mode set
	SSID	WLAN network name created by the WI-FI B EBA GATEWAY [BeBa_Wifi_<Mac address>]
	BSSID	MAC address
	Channel	Channel which transmits/receives the board
	Security	Security type set for the network operated by B EBA WI-FI GATEWAY

8.1) Step1: U-Link PARAMETERS SETTING

The B EBA WI-FI GATEWAY board to be used with dedicated BFT software needed to set the parameters for the U-Link by clicking on the [U-Link] configuration in this installation menu.

<p>U-Link Configuration:</p> <p>Password AES: [12345] Port: [111]</p>	Password AES	Password for the AES encryption protocol U-Link. Length between 8 and 16 characters. Bft12345 default value
	Port:	Port corresponding to the U-link service of the B EBA WI-FI GATEWAY board. 1111 default value

After changing the parameters click [**Save**]

8.2) Step2: PARAMETER SETTING Access Point

In order to change the default access point, click [**Access Point**] in the installation menu.
 Change the settings if necessary

<p>Access point configuration:</p> <p>SSID: BeBa_Wifi_000B70B1 Channel: 1 Security: Open IP address: 192.168.1.1 IP netmask: 255.255.255.0 DHCP: <input checked="" type="checkbox"/> DHCP range: 192.168.1.2 DNS: []</p>	SSID	WLAN network name created by the WI-FI B EBA GATEWAY [BeBa_Wifi_<Mac address>] Not modifiable
	Channel	Channel which transmits/receives the board If multiple B EBA WI-FI GATEWAY are used in proximity configured as an access point, reduce radio interference by selecting different channels for each of the adjacent B EBA WI-FI GATEWAY. A spacing of four channels is recommended between the adjacent B EBA WI-FI GATEWAY (for example, use channels 1 and 5, or 6 and 10).
	Security	Security type set for the network operated by B EBA WI-FI GATEWAY. Possible settings: -Open - Open network, without encryption -WPA-PSK - Network encrypted according to WPA-PSK Protocol -WPA2-PSK - Network encrypted according to WPA2-PSK Protocol -WEP - Network encrypted according to WEP Protocol
	IP Address	IP address assigned to the B EBA WI-FI GATEWAY
	IP netmask	Netmask setting
	DHCP	Enables/Disables DHCP of the DHCP server
	DHCP start IP Address	Value of the first address used by the DHCP server. 5 IP devices max.

To make the changes, click [**Apply**], after this the board cannot be accessed with the default configuration.

Note: The data required in order to interface the B EBA WI-FI GATEWAY board with the BFT software is:

- IP of the board
- Port must answer the U-link service
- Password AES

9) CASE 2: CONFIGURATION AS CLIENT (FIG. D)

This type of connection allows to manage a U-Link system using the B EBA WI-FI GATEWAY board connected to an existing WLAN network which is connected to the PC, smartphone and/or tablet always through dedicated BFT software.

1. Connect the PC, smartphone and/or tablet to the SSID network identified by the name **BeBa_Wifi_<Mac address>** (using WPA2-PSK security type, and the default password BEBAWIFI) defined by the EBA B WI-FI GATEWAY. The Mac address of the B EBA WI-FI GATEWAY is what is on the label on the B EBA WI-FI GATEWAY board.

The methods for connecting to the WiFi network vary depending on the PC, smartphone and/or tablet and operating system adopted, to understand how to connect, check the instructions of the device.

2. After connecting to the B EBA WI-FI GATEWAY open the browser (be sure not to have the proxy server active), type in the address bar the default address **192.168.1.1** of the B EBA WI-FI GATEWAY

It reaches the current configuration of the module page

On the screen is shown:

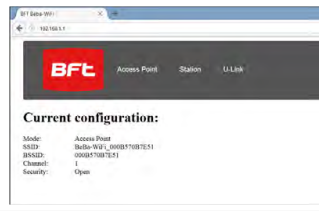
	<table border="1" style="width: 100%; border-collapse: collapse;"> <tr> <td style="width: 20%;">Mode</td> <td>Operating mode set</td> </tr> <tr> <td>SSID</td> <td>WLAN network name created by the WI-FI B EBA GATEWAY [BeBa_Wifi_<Mac address>]</td> </tr> <tr> <td>BSSID</td> <td>Mac address</td> </tr> <tr> <td>Channel</td> <td>Channel which transmits/receives the board</td> </tr> <tr> <td>Security</td> <td>Security type set for the network operated by B EBA WI-FI GATEWAY</td> </tr> </table>	Mode	Operating mode set	SSID	WLAN network name created by the WI-FI B EBA GATEWAY [BeBa_Wifi_<Mac address>]	BSSID	Mac address	Channel	Channel which transmits/receives the board	Security	Security type set for the network operated by B EBA WI-FI GATEWAY	
Mode	Operating mode set											
SSID	WLAN network name created by the WI-FI B EBA GATEWAY [BeBa_Wifi_<Mac address>]											
BSSID	Mac address											
Channel	Channel which transmits/receives the board											
Security	Security type set for the network operated by B EBA WI-FI GATEWAY											

9.1) Step1: U-Link PARAMETER SETTING

The B EBA WI-FI GATEWAY board to be used with dedicated BFT software needed to set the parameters for the U-Link by clicking on the **[U-Link]** configuration in this installation menu.

	<table border="1" style="width: 100%; border-collapse: collapse;"> <tr> <td style="width: 20%;">Password AES</td> <td>Password for the AES encryption protocol U-Link. Length between 8 and 16 characters. Bft12345 default value</td> </tr> <tr> <td>Port:</td> <td>Port corresponding to the U-link service of the B EBA WI-FI GATEWAY board. 1111 default value</td> </tr> </table>	Password AES	Password for the AES encryption protocol U-Link. Length between 8 and 16 characters. Bft12345 default value	Port:	Port corresponding to the U-link service of the B EBA WI-FI GATEWAY board. 1111 default value	
Password AES	Password for the AES encryption protocol U-Link. Length between 8 and 16 characters. Bft12345 default value					
Port:	Port corresponding to the U-link service of the B EBA WI-FI GATEWAY board. 1111 default value					

After changing the parameters click **[Save]**

9.2) Step2: Client PARAMETER SETTING

In order to change the default setting of the B EBA WI-FI GATEWAY board to set it as a client click **[Station]** in the installation menu.

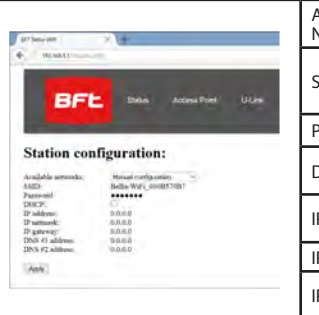
	<table border="1" style="width: 100%; border-collapse: collapse;"> <tr> <td style="width: 20%;">Available Networks</td> <td>Shows the list of networks that are visible and accessible from the module</td> </tr> <tr> <td>SSID</td> <td>It indicates the wireless network to connect to. If the network is not visible by setting [manual configuration] in [Available Networks] it is possible to type the hidden wireless network name to which you want to connect.</td> </tr> <tr> <td>Password</td> <td>Password of the WiFi network to connect to.</td> </tr> <tr> <td>DHCP</td> <td>Enable it if is expected that the WLAN to which to connect automatically associates the IP of the B EBA WI-FI GATEWAY</td> </tr> <tr> <td>IP address</td> <td>Setting the IP address of the B EBA WI-FI GATEWAY board if DHCP is not enabled.</td> </tr> <tr> <td>IP netmask</td> <td>It sets the netmask of the B EBA WI-FI GATEWAY board if DHCP is not enabled.</td> </tr> <tr> <td>IP gateway</td> <td>Setting the IP address of the router to which to connect if DHCP is not enabled.</td> </tr> </table>	Available Networks	Shows the list of networks that are visible and accessible from the module	SSID	It indicates the wireless network to connect to. If the network is not visible by setting [manual configuration] in [Available Networks] it is possible to type the hidden wireless network name to which you want to connect.	Password	Password of the WiFi network to connect to.	DHCP	Enable it if is expected that the WLAN to which to connect automatically associates the IP of the B EBA WI-FI GATEWAY	IP address	Setting the IP address of the B EBA WI-FI GATEWAY board if DHCP is not enabled.	IP netmask	It sets the netmask of the B EBA WI-FI GATEWAY board if DHCP is not enabled.	IP gateway	Setting the IP address of the router to which to connect if DHCP is not enabled.	
Available Networks	Shows the list of networks that are visible and accessible from the module															
SSID	It indicates the wireless network to connect to. If the network is not visible by setting [manual configuration] in [Available Networks] it is possible to type the hidden wireless network name to which you want to connect.															
Password	Password of the WiFi network to connect to.															
DHCP	Enable it if is expected that the WLAN to which to connect automatically associates the IP of the B EBA WI-FI GATEWAY															
IP address	Setting the IP address of the B EBA WI-FI GATEWAY board if DHCP is not enabled.															
IP netmask	It sets the netmask of the B EBA WI-FI GATEWAY board if DHCP is not enabled.															
IP gateway	Setting the IP address of the router to which to connect if DHCP is not enabled.															

For the changes to take effect, click on **[Apply]**. After that the board is no longer accessible through the browser.

In order to restore the default configuration of the B EBA WI-FI GATEWAY board, see section **RESET TO FACTORY SETTINGS**.

Note: for correct operation with the BFT software the B EBA WI-FI GATEWAY board must be accessed with a fixed IP and this can be possible:

- setting it directly on the browser during client setup
- by setting a rule in the router that manages the WiFi network to which to connect that associates the Mac address of the same IP board.

Note: The data required in order to interface the B EBA WI-FI GATEWAY board with the BFT software is:

- IP of the board
- Port must answer the U-link service
- Password AES